

Spin R 030 / teknisk datablad

STANDARDKOMBINASJONEN SPIN R 030 BESTÅR AV:
 12 TRINN I HPL-LAMINAT - ALM
 12 BÆREELEMENTER I STÅL
 REKKVERK MED SPILER FOR INNSIDEN

NYANSER OG FARGER



ALM-NYANSER:
 LYS, MØRK



STÅLFARGER:
 PREGET HVIT 9010,
 PREGET SVART 9005,
 STØPEJERNGRÅ

Tabell 1

	TRAPPEHØYDE I CM	TRAPPETRINN	OPPTRINN	TILLEGGSARTIKLER
				TRAPPETRINN
ØKNINGER	fra 275 til 373	15	16	+ 3
	fra 258 til 349	14	15	+ 2
	fra 242 til 327	13	14	+ 1
STANDARD	fra 225 til 303	12	13	12 TRINN I HPL-LAMINAT - ALM + 12 BÆREELEMENTER I STÅL + REKKVERK MED SPILER FOR INNSIDEN
REDUKSJONER	fra 208 til 279	11	12	-
	fra 191 til 255	10	11	-



REGULERBARE OPPTRINN FRA 17 TIL 23,5 CM

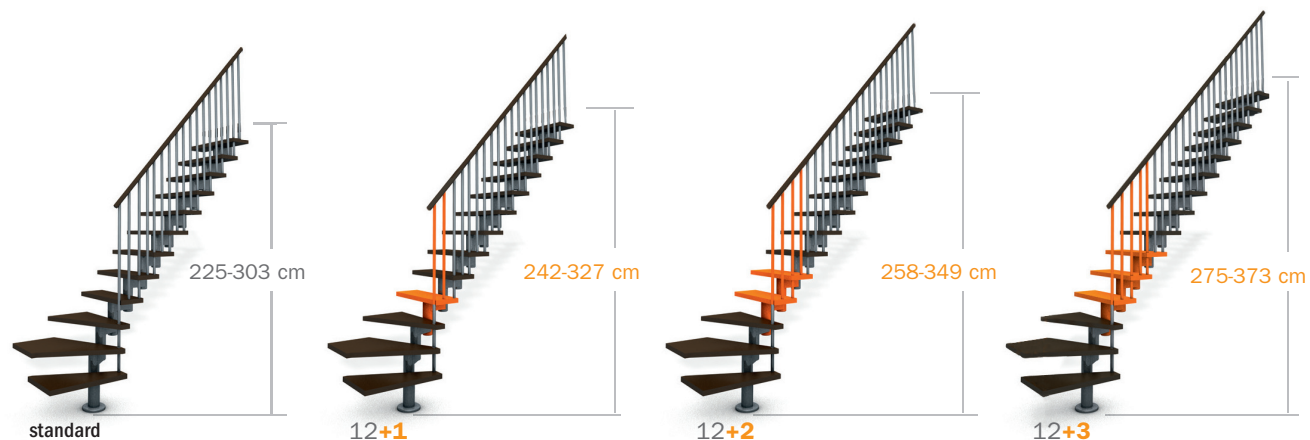

OVERSIKT OVER TILLEGGSARTIKLER

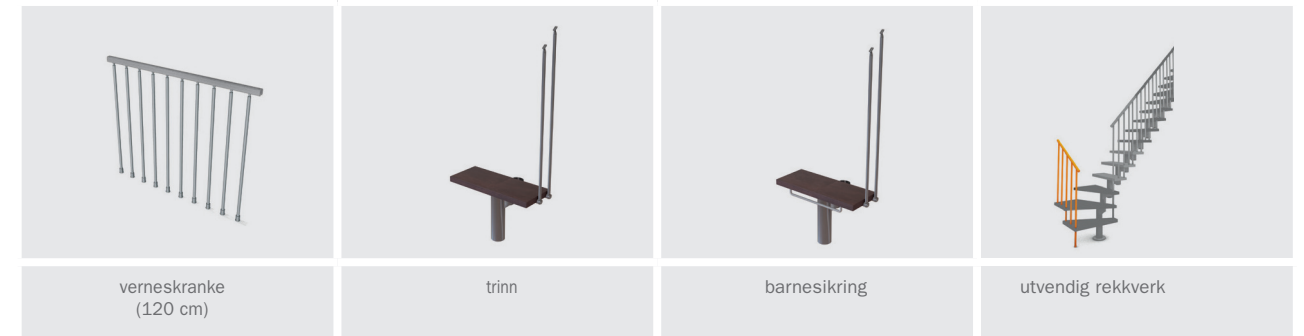

EKSTRA VERNESKRANKE

Nødvendig for å beskytte åpningen i overetasjen (fig. 1). Dette er en modulseksjon på 120 cm som består av 10 spiler, håndløper og festelementer.

TYPE HULLER OG VERNESKRANKER



UTVENDIG REKKVERK

Det ekstra utvendige rekkverket består av 5 spiler, håndløper og festelementer, og monteres som beskyttelse hvis trappens utside er langt fra veggen. Det utvendige rekkverket gjør trappen 5 cm bredere.

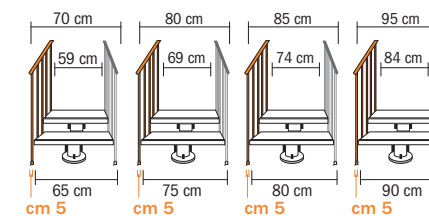

UTVENDIG REKKVERK (65-75/80-90)

Du kan telle hvor mange spiler du trenger på utsiden av trappen. Spilene tilsvarer punktene på utsiden.

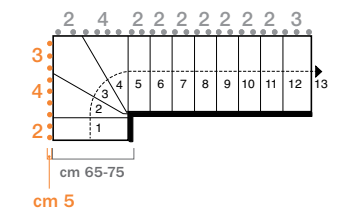

Eksempel: Hvis du ønsker å montere det utvendige rekkverket bare på utsiden av trappen må du summere antall spiler: $2+4+3=9$. Du må med andre ord bestille 2 ekstra utvendige rekkverk.

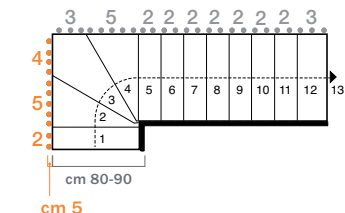

Eksempel: Hvis du ønsker å montere det utvendige rekkverket bare på utsiden av trappen må du summere antall spiler: $2+5+4=11$. Du må med andre ord bestille 3 ekstra utvendige rekkverk.

EKSTRA TRINN

For å oppnå en høyde på 373 cm må du kjøpe ett eller flere ekstra trinn, bestående av struktur, trinn og spiler (Tab. 1).

RØRFORMET BARNESIKRING

Med denne kan du redusere avstanden mellom trinnene ytterligere, og dermed unngå at barn faller ned.



SVINGRETNING

til høyre eller venstre

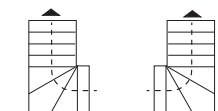

Svingretningen, til høyre eller venstre, bestemmes når trappen skal plasseres.

Spin R 030

Råd for valget

Anbefalt åpning i bjelkelaget skal være minst like stor som trappen, minus to trinn.

Inntrinnene måler:

- fra 18 til 22 cm for bredder på 65 eller 75 cm

- fra 22 til 26 cm for bredder på 80 eller 90 cm.

Forskjellig plassering av de 12 trinnene og valget av inntrinn, gjør det mulig å realisere 312 forskjellige konfigurasjoner. Tegningene viser maksimum- og minimumstørrelsen på de ulike konfigurasjonene som er mulige med Spin R 030 med 1/4 sving (L), 2/4 sving (U) og rettlinjert (I).

Har du allerede åpning i bjelkelaget?

Finn blant de 312 tegningene den som har en åpning som er mindre enn åpningen i bjelkelaget. Husk at åpningen i bjelkelaget må være minst like stor som trappen, minus to trinn. Ta hensyn til om det er en 65 eller 75 cm bred modell, eller om det er en 80 eller 90 cm bred modell når du eventuelt skal kjøpe tilleggsartikler.

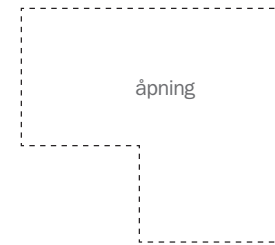

Har du ikke laget åpning i bjelkelaget ennå?

Finn blant de 312 tegningene den som egner seg best for trappeoppgangen din. Åpningen i bjelkelaget skal være minst like stor som trappen, minus to trinn.

Ta hensyn til om det er en 65 eller 75 cm bred modell, eller om det er en 80 eller 90 cm bred modell når du eventuelt skal kjøpe tilleggsartikler.

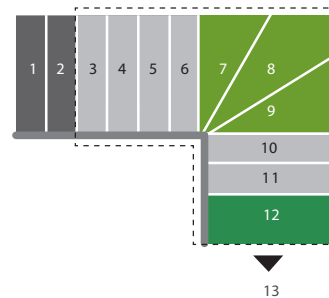

Tegnforklaring:

- de to første trinnene utenfor åpningen
- trinn med regulerbart inntrinn
- svingtrinn
- sluttrinn

65 Spin R 030

Regulering av trinndybden:

- 18, 19, 20, 21, 22 cm regulerbar
- 29 cm fast

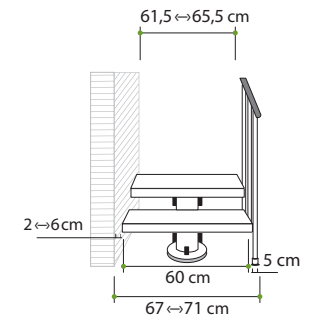
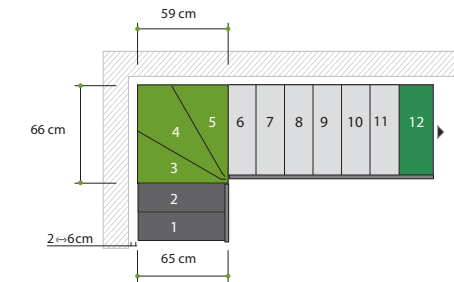

75 Spin R 030

Regulering av trinndybden:

- 18, 19, 20, 21, 22 cm regulerbar
- 29 cm fast

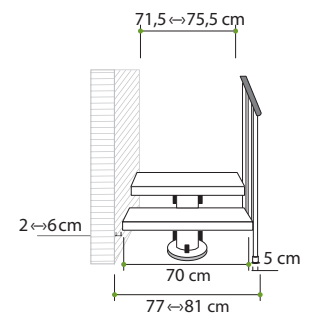
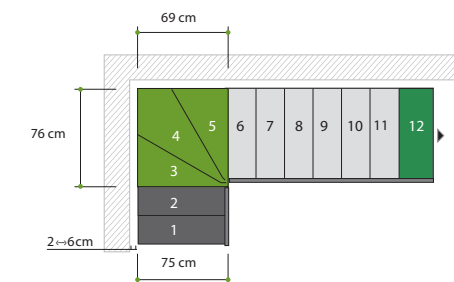

80 Spin R 030

Regulering av trinndybden:

- 22, 23, 24, 25, 26 cm regulerbar
- 33 cm fast

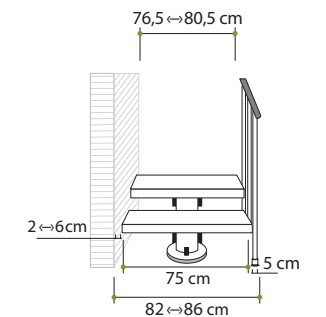
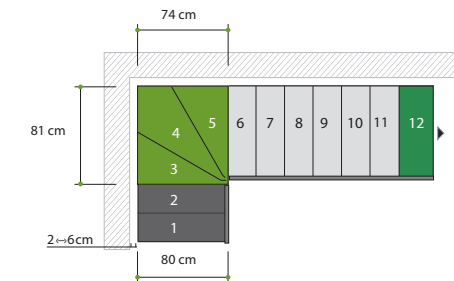

90 Spin R 030

Regulering av trinndybden:

- 22, 23, 24, 25, 26 cm regulerbar
- 33 cm fast

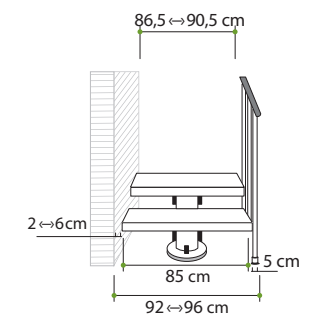
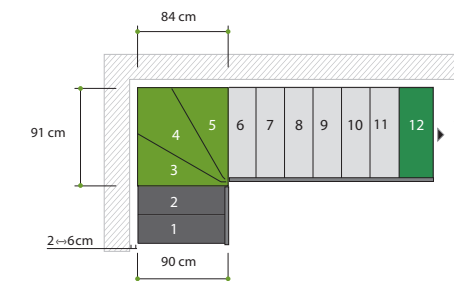



Spin R 030 65-75-80-90

Råd for valget

Målene i konfigurasjonene I, L og U, vist nedenfor, inkluderer minsteavstanden på 2 cm som man må ha mellom en eventuell vegg og trappen.

Tegnforklaring:

-  de to første trinnene utenfor åpningen
-  trinn med regulerbart inntrinn
-  sluttrinn

Spin R 030 65 L - 75 L - 80 L - 90 L

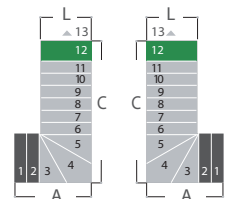
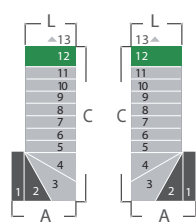
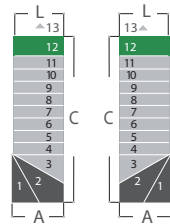

L (cm)	A (cm)	C (cm)
67	68	234-242-250-258-266
77	78	244-252-260-268-276
82	83	285-293-301-309-317
92	93	295-303-311-319-327

L (cm)	A (cm)	C (cm)
67	86-87-88-89-90	216-223-230-237-244
77	96-97-98-99-100	226-233-240-247-254
82	105-106-107-108-109	263-270-277-284-291
92	115-116-117-118-119	273-280-287-294-301

L (cm)	A (cm)	C (cm)
67	104-106-108-110-112	198-204-210-216-222
77	114-116-118-120-122	208-214-220-226-232
82	127-129-131-133-135	241-247-253-259-265
92	137-139-141-143-145	251-257-263-269-275

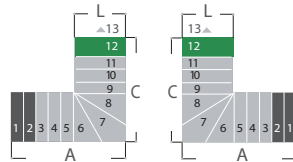
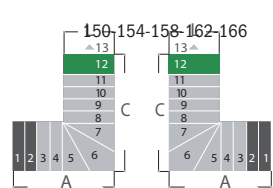
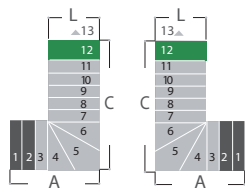

L (cm)	A (cm)	C (cm)
67	122-125-128-131-134	180-185-190-195-200
77	132-135-138-141-144	190-195-200-205-210
82	149-152-155-158-161	219-224-229-234-239
92	159-162-165-168-171	229-234-239-244-249

L (cm)	A (cm)	C (cm)
67	140-144-148-152-156	162-166-170-174-178
77	150-154-158-162-166	172-176-180-184-188
82	171-175-179-183-187	197-201-205-209-213
92	181-185-189-193-197	207-211-215-219-223

L (cm)	A (cm)	C (cm)
67	158-163-168-173-178	144-147-150-153-156
77	168-173-178-183-188	154-157-160-163-166
82	193-198-203-208-213	175-178-181-184-187
92	203-208-213-218-223	185-188-191-194-197

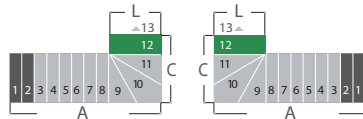
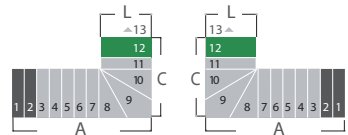
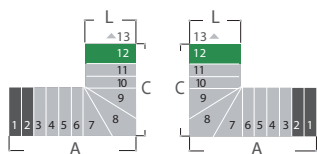

L (cm)	A (cm)	C (cm)
67	176-182-188-194-200	126-128-130-132-134
77	186-192-198-204-210	136-138-140-142-144
82	215-221-227-233-239	153-155-157-159-161
92	225-231-237-243-249	163-165-167-169-171

L (cm)	A (cm)	C (cm)
67	194-201-208-215-222	108-109-110-111-112
77	204-211-218-225-232	118-119-120-121-122
82	237-244-251-258-265	131-132-133-134-135
92	247-254-261-268-275	141-142-143-144-145

L (cm)	A (cm)	C (cm)
67	212-220-228-236-244	90
77	222-230-238-246-254	100
82	259-267-275-283-291	109
92	269-277-285-293-301	119

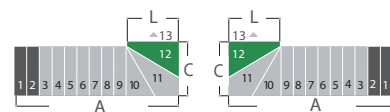

L (cm)	A (cm)	C (cm)
67	230-239-248-257-266	70
77	240-249-258-267-276	80
82	281-290-299-308-317	86
92	291-300-309-318-327	96

Spin R 030 65 I - 75 I - 80 I - 90 I

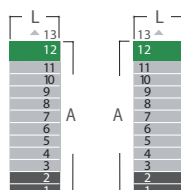

L (cm)	A (cm)
67	227-238-249-260-271
77	227-238-249-260-271
82	275-286-297-308-319
92	275-286-297-308-319

Spin R 030 65 U - 75 U - 80 U - 90 U

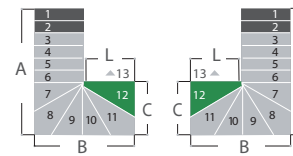

L (cm)	A (cm)	B (cm)	C (cm)
67	176-182-188-194-200	130	70
77	186-192-198-204-210	149	80
82	215-221-227-233-239	160	86
92	225-231-237-243-249	180	96

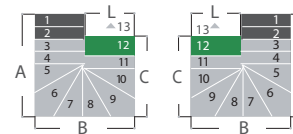

L (cm)	A (cm)	B (cm)	C (cm)
67	140-144-148-152-156	130	108-109-110-111-112
77	150-154-158-162-166	150	118-119-120-121-122
82	171-175-179-183-187	160	131-132-133-134-135
92	181-185-189-193-197	180	141-142-143-144-145

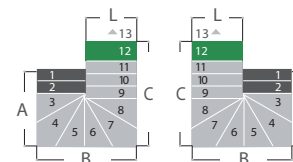

L (cm)	A (cm)	B (cm)	C (cm)
67	104-106-108-110-112	130	144-147-150-153-156
77	114-116-118-120-122	150	154-157-160-163-166
82	127-129-131-133-135	160	175-178-181-184-187
92	137-139-141-143-145	180	185-188-191-194-197

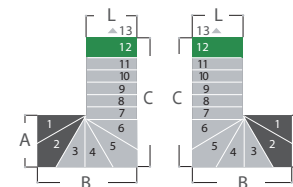

L (cm)	A (cm)	B (cm)	C (cm)
67	68	130	180-185-190-195-200
77	78	150	190-195-200-205-210
82	83	160	219-224-229-234-239
92	93	180	229-234-239-244-249

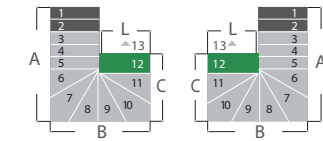

L (cm)	A (cm)	B (cm)	C (cm)
67	158-163-168-173-178	130	90
77	168-173-178-183-188	149	100
82	193-198-203-208-213	160	109
92	203-208-213-218-223	180	119

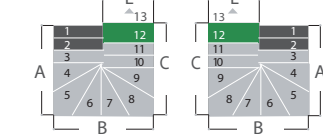

L (cm)	A (cm)	B (cm)	C (cm)
67	122-125-128-131-134	130	126-128-130-132-134
77	132-135-138-141-144	150	136-138-140-142-144
82	149-152-155-158-161	160	153-155-157-159-161
92	159-162-165-168-171	180	163-165-167-169-171

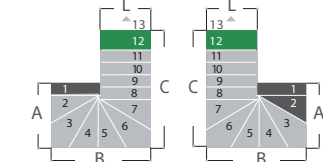

L (cm)	A (cm)	B (cm)	C (cm)
67	86-87-88-89-90	130	162-166-170-174-178
77	96-97-98-99-100	150	172-176-180-184-188
82	105-106-107-108-109	160	197-201-205-209-213
92	115-116-117-118-119	180	207-211-215-219-223

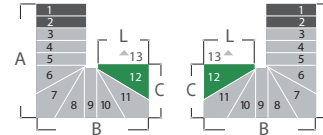

L (cm)	A (cm)	B (cm)	C (cm)
67	158-163-168-173-178	147-148-149-150-151	70
77	168-173-178-183-188	167-168-169-170-171	80
82	193-198-203-208-213	181-182-183-184-185	86
92	203-208-213-218-223	201-202-203-204-205	96

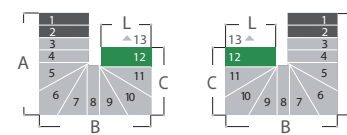

L (cm)	A (cm)	B (cm)	C (cm)
67	140-144-148-152-156	147-148-149-150-151	90
77	150-154-158-162-166	167-168-169-170-171	100
82	171-175-179-183-187	181-182-183-184-185	109
92	181-185-189-193-197	201-202-203-204-205	119

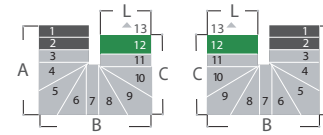

L (cm)	A (cm)	B (cm)	C (cm)
67	122-125-128-131-134	147-148-149-150-151	108-109-110-111-112
77	132-135-138-141-144	167-168-169-170-171	118-119-120-121-122
82	149-152-155-158-161	181-182-183-184-185	131-132-133-134-135
92	159-162-165-168-171	201-202-203-204-205	141-142-143-144-145

Spin R 030 65 U - 75 U - 80 U - 90 U

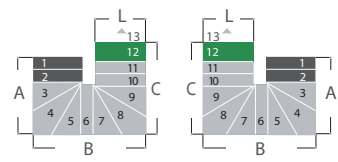

L (cm)	A (cm)	B (cm)	C (cm)
67	104-106-108-110-112	147-148-149-150-151	126-128-130-132-134
77	114-116-118-120-122	167-168-169-170-171	136-138-140-142-144
82	127-129-131-133-135	181-182-183-184-185	153-155-157-159-161
92	137-139-141-143-145	201-202-203-204-205	163-165-167-169-171

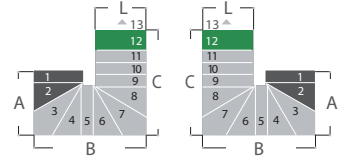

L (cm)	A (cm)	B (cm)	C (cm)
67	86-87-88-89-90	147-148-149-150-151	144-147-150-153-156
77	96-97-98-99-100	167-168-169-170-171	154-157-160-163-166
82	105-106-107-108-109	181-182-183-184-185	175-178-181-184-187
92	115-116-117-118-119	201-202-203-204-205	185-188-191-194-197

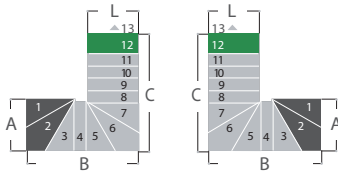

L (cm)	A (cm)	B (cm)	C (cm)
67	68	147-148-149-150-151	162-166-170-174-178
77	78	167-168-169-170-171	172-176-180-184-188
82	83	181-182-183-184-185	197-201-205-209-213
92	93	201-202-203-204-205	207-211-215-219-223

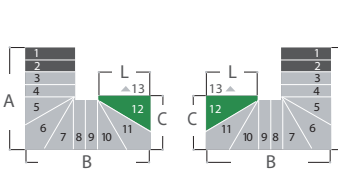

L (cm)	A (cm)	B (cm)	C (cm)
67	140-144-148-152-156	165-167-169-171-173	70
77	150-154-158-162-166	185-187-189-191-193	80
82	171-175-179-183-187	203-205-207-209-211	86
92	181-185-189-193-197	223-225-227-229-231	96

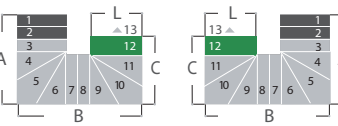

L (cm)	A (cm)	B (cm)	C (cm)
67	122-125-128-131-134	165-167-169-171-173	90
77	132-135-138-141-144	185-187-189-191-193	100
82	149-152-155-158-161	203-205-207-209-211	109
92	159-162-165-168-171	223-225-227-229-231	119

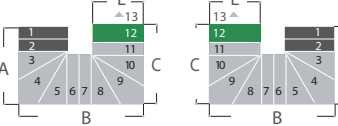

L (cm)	A (cm)	B (cm)	C (cm)
67	104-106-108-110-112	165-167-169-171-173	108-109-110-111-112
77	114-116-118-120-122	185-187-189-191-193	118-119-120-121-122
82	127-129-131-133-135	203-205-207-209-211	131-132-133-134-135
92	137-139-141-143-145	223-225-227-229-231	141-142-143-144-145

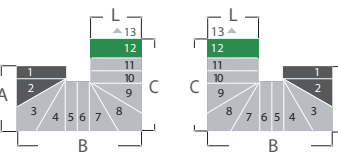

L (cm)	A (cm)	B (cm)	C (cm)
67	86-87-88-89-90	165-167-169-171-173	126-128-130-132-134
77	96-97-98-99-100	185-187-189-191-193	136-138-140-142-144
82	105-106-107-108-109	203-205-207-209-211	153-155-157-159-161
92	115-116-117-118-119	223-225-227-229-231	163-165-167-169-171

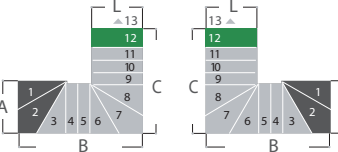

L (cm)	A (cm)	B (cm)	C (cm)
67	68	165-167-169-171-173	144-147-150-153-156
77	78	185-187-189-191-193	154-157-160-163-166
82	83	203-205-207-209-211	175-178-181-184-187
92	93	223-225-227-229-231	185-188-191-194-197

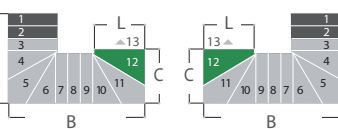

L (cm)	A (cm)	B (cm)	C (cm)
67	122-125-128-131-134	183-186-189-192-195	70
77	132-135-138-141-144	203-206-209-212-215	80
82	149-152-155-158-161	225-228-231-234-237	86
92	159-162-165-168-171	245-248-251-254-257	96

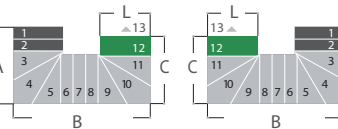

L (cm)	A (cm)	B (cm)	C (cm)
67	104-106-108-110-112	183-186-189-192-195	90
77	114-116-118-120-122	203-206-209-212-215	100
82	127-129-131-133-135	225-228-231-234-237	109
92	137-139-141-143-145	245-248-251-254-257	119

Spin R 030 65 U - 75 U - 80 U - 90 U

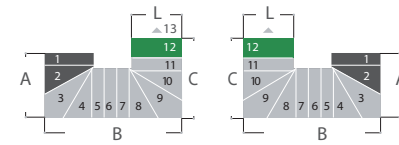

L (cm)	A (cm)	B (cm)	C (cm)
67	86-87-88-89-90	183-186-189-192-195	108-109-110-111-112
77	96-97-98-99-100	203-206-209-212-215	118-119-120-121-122
82	105-106-107-108-109	225-228-231-234-237	131-132-133-134-135
92	115-116-117-118-119	245-248-251-254-257	141-142-143-144-145

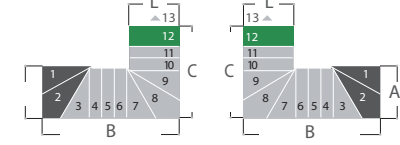

L (cm)	A (cm)	B (cm)	C (cm)
67	68	183-186-189-192-195	126-128-130-132-134
77	78	203-206-209-212-215	136-138-140-142-144
82	83	225-228-231-234-237	153-155-157-159-161
92	93	245-248-251-254-257	163-165-167-169-171

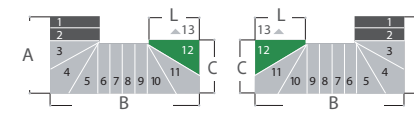

L (cm)	A (cm)	B (cm)	C (cm)
67	104-106-108-110-112	201-205-209-213-217	70
77	114-116-118-120-122	221-225-229-233-237	80
82	127-129-131-133-135	247-251-255-259-263	86
92	137-139-141-143-145	267-271-275-279-283	96

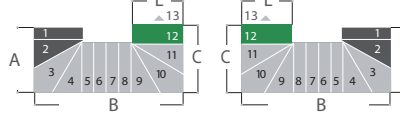

L (cm)	A (cm)	B (cm)	C (cm)
67	86-87-88-89-90	201-205-209-213-217	90
77	96-97-98-99-100	221-225-229-233-237	100
82	105-106-107-108-109	247-251-255-259-263	109
92	115-116-117-118-119	267-271-275-279-283	119

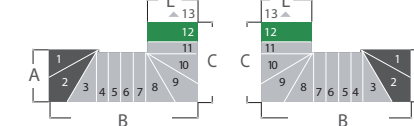

L (cm)	A (cm)	B (cm)	C (cm)
67	68	201-205-209-213-217	108-109-110-111-112
77	78	221-225-229-233-237	118-119-120-121-122
82	83	247-251-255-259-263	131-132-133-134-135
92	93	267-271-275-279-283	141-142-143-144-145

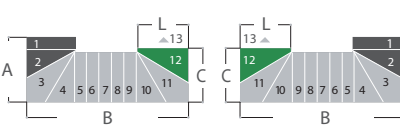

L (cm)	A (cm)	B (cm)	C (cm)
67	86-87-88-89-90	219-224-229-234-239	70
77	96-97-98-99-100	239-244-249-254-259	80
82	105-106-107-108-109	269-274-279-284-289	86
92	115-116-117-118-119	289-294-299-304-309	96

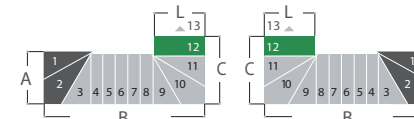

L (cm)	A (cm)	B (cm)	C (cm)
67	68	219-224-229-234-239	90
77	78	239-244-249-254-259	100
82	83	269-274-279-284-289	109
92	93	289-294-299-304-309	119

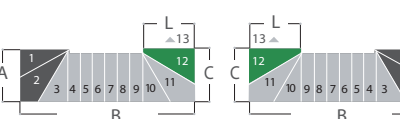

L (cm)	A (cm)	B (cm)	C (cm)
67	68	237-243-249-255-261	70
77	78	257-263-269-275-281	80
82	83	291-297-303-309-315	86
92	93	311-317-323-329-335	96